

# Aufbauanleitung / assembly instructions mod. 5651, 5652, 5656, 5657 ARA fest

Bitte diese Aufbauanleitung sorgfältig aufbewahren!

Please keep this assembly instructions carefully!

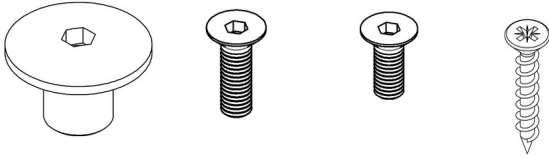

**8x**  
**M10**  
Metallstreben-  
paket

**4x**  
**M6 x 20**  
Metallstreben-  
paket

**4x**  
**M6 x 16**  
Metallstreben-  
paket

**8x**  
**4,5 x 30**  
Oberbaupaket



1. Montagematerial.  
1. Fitting material.

2. Die Stahl Bodenplatte auf gepolsterte Montageböcken legen.  
2. Put the steel base plate onto padded assembling trestles.

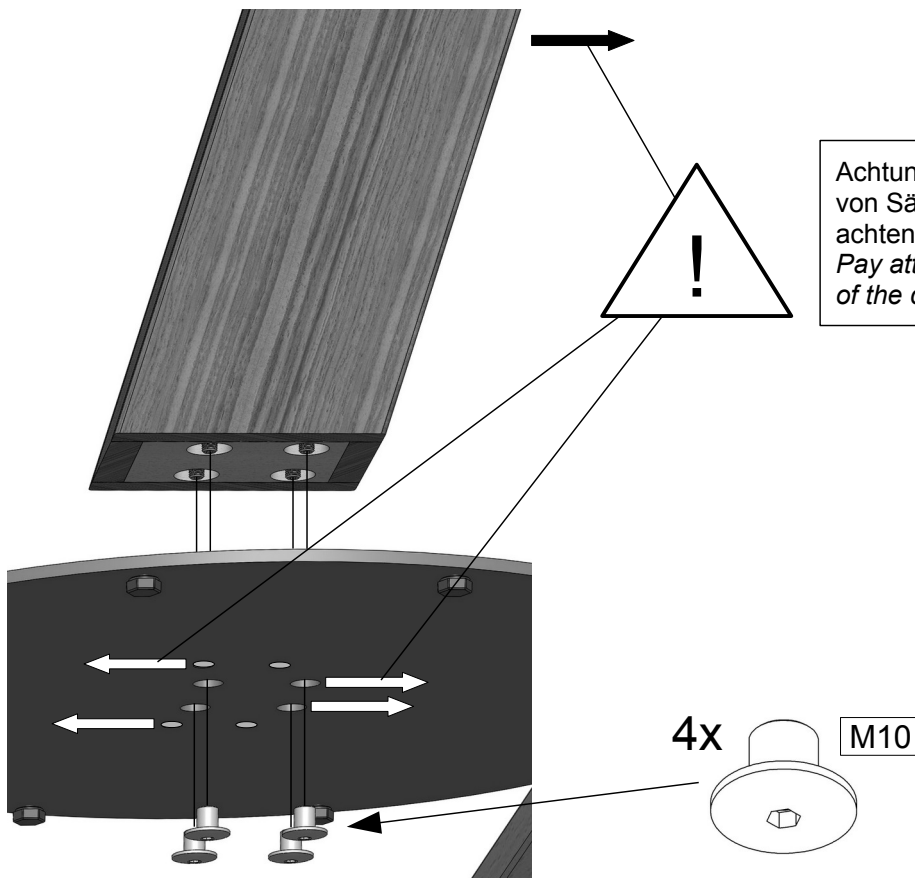

Achtung, auf die Ausrichtung von Säule und Bohrungen achten!  
Pay attention to the alignment of the column and the holes!

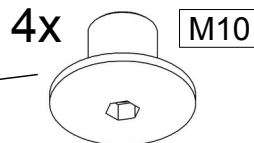
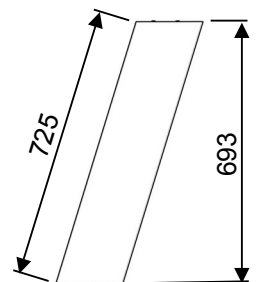

3. Die Holzsäule mit 4 Rundmuttern zunächst **loose** fixieren.  
3. First **loosely** fix the wooden table column with 4 round nuts.

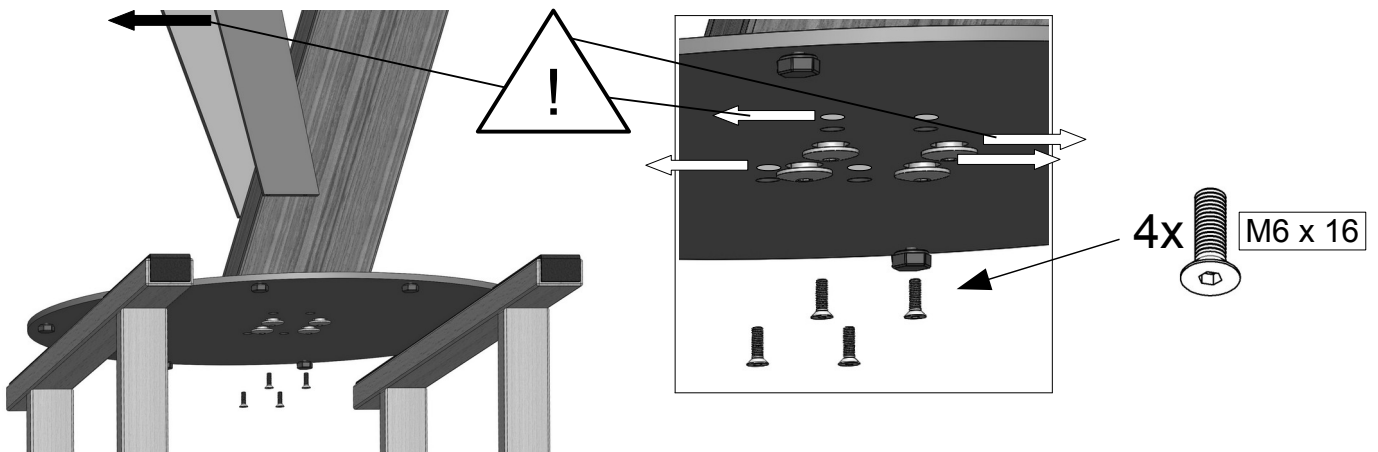

4. Die beiden Metallstreben mit je zwei Senkkopfschrauben fixieren.  
4. Fix the two metal bars with each two countersunk screws.

Zur Überprüfung / for verification:

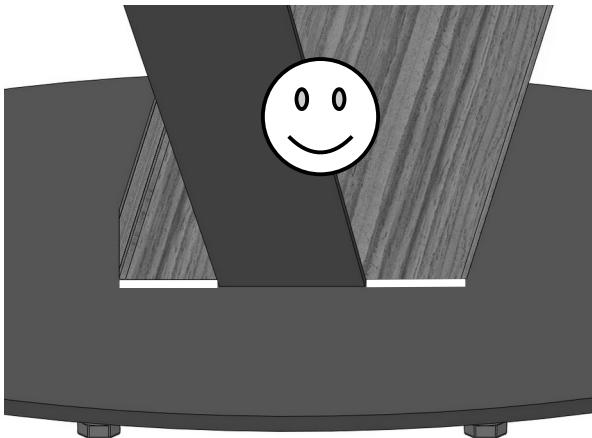

Richtig montiert / Properly mounted.

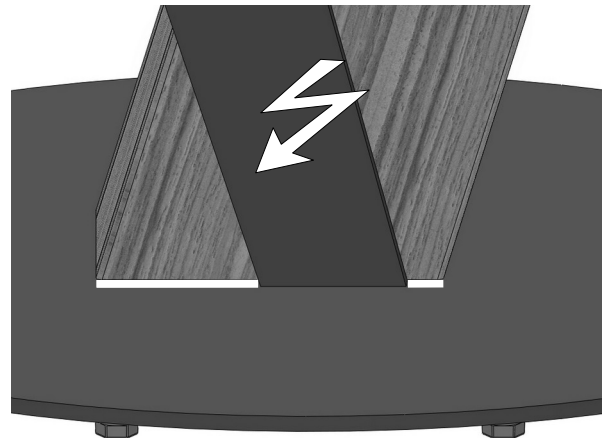

Falsch montiert / Incorrectly mounted.

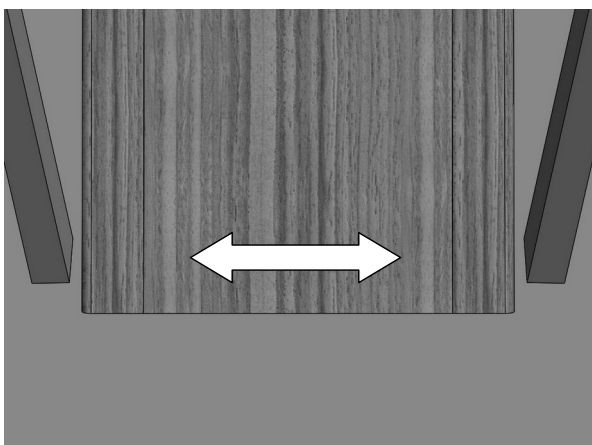

- 5a. Die Holzsäule mittig zwischen den Metallstreben ausrichten.  
5a. Align the wooden column in the middle between the metal struts.

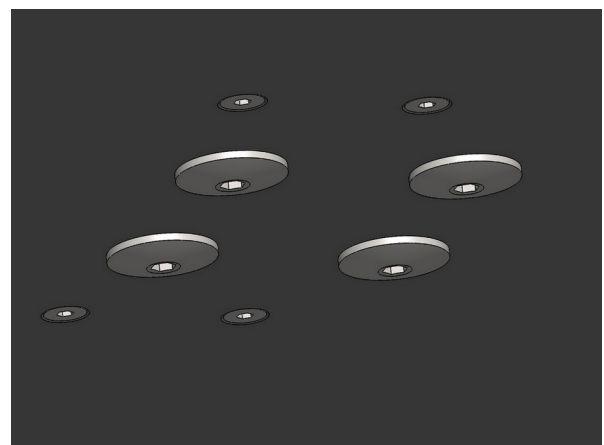

- 5b. Die vier Rundmuttern nun fest anziehen.  
5b. Now tighten the four round nuts firmly.

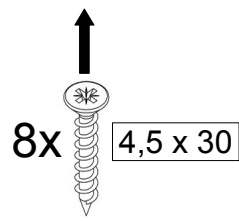
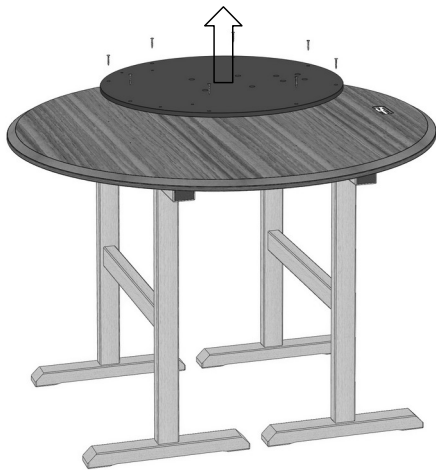

6. Den Plattenträger abschrauben.  
6. *Unscrew the retaining plate.*

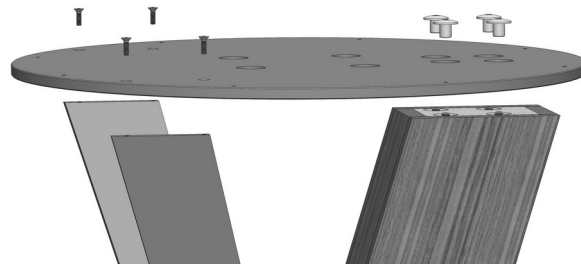
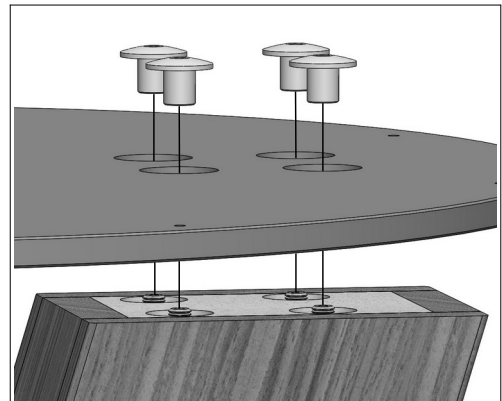
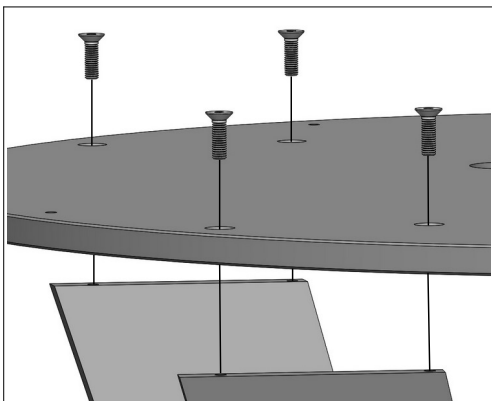
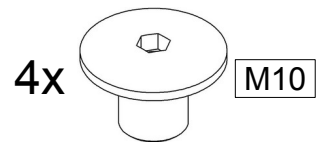

7. Die Halteplatte fixieren.  
Anschließend den Unterbau auf den Boden stellen.  
7. *Fix the holding plate.*  
*Then put the base onto the floor.*

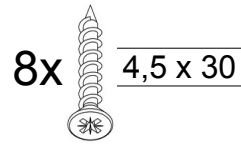
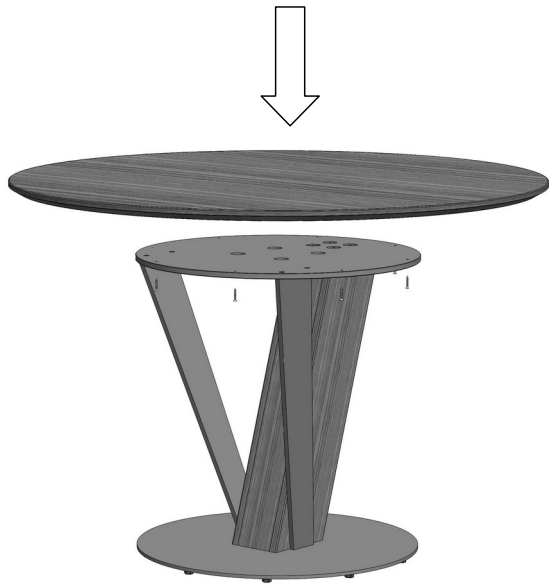

8. Den Oberbau auf den Unterbau legen und mit 8 Spax-Schrauben verbinden.  
8. *Put the table top onto the table base and fix with 8 Spax-screws.*



9. **Fertig.**  
9. **Ready.**